

EMPIRE WOODEN LINE

Modern lecterns designed with style and elegance.



EMPIRE

DESCRIPTION:

Crafted from the wood of your choice (maple or oak) and finished with a specialized stain. Featuring Stainless Steel front corners. Wooden podiums includes concealed A/V components.



front detail



side detail



back detail

*Gunstock Walnut on Oak Shown

SIGNAGE

DESCRIPTION:

Branding options for our Empire podium.

3D ACRYLIC

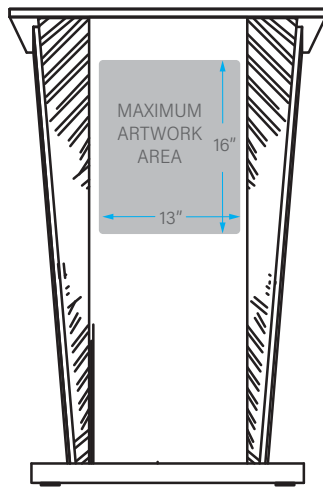

3D Acrylic Signage
(3-SIGN-RETAIN3D)

*Rosewood on Maple Shown



353 Saunders Rd, Unit 10-11, Barrie ON L4N 9A3
Tel: 705-739-6745 Fax: 705-739-1228
www.podiumpros.com



Stain options for our Empire podium.



Rosewood
(W200)



Pecan
(W239)

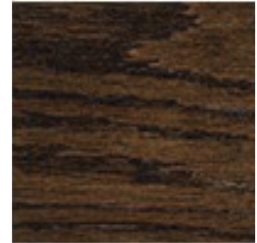

Black
(W240)



Gunstock Walnut
(W247)

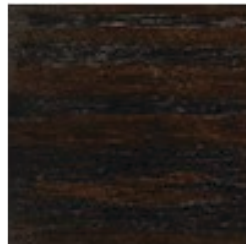

Brown Mahogany
(W260)



Brown Cherry
(W263)



Regency Mahogany
(W268)

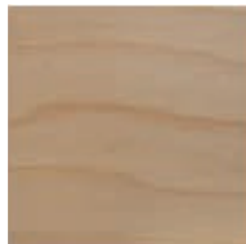

Clear Maple
(none)
*only available with maple

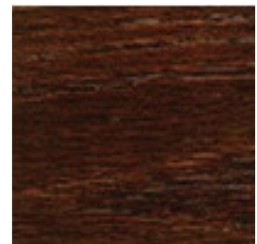

Golden Oak
(W201)
*only available with oak

****Brochure is for visual reference only. Final product may vary due to production processes, materials, and color reproduction.**



DIMENSIONS

DESCRIPTION:

- Dimensions and weight of assembled Empire podium.
- Dimensions and weight of assembled Empire podium, including packaging.

ASSEMBLED EMPIRE PODIUM

Weight: ~185lbs

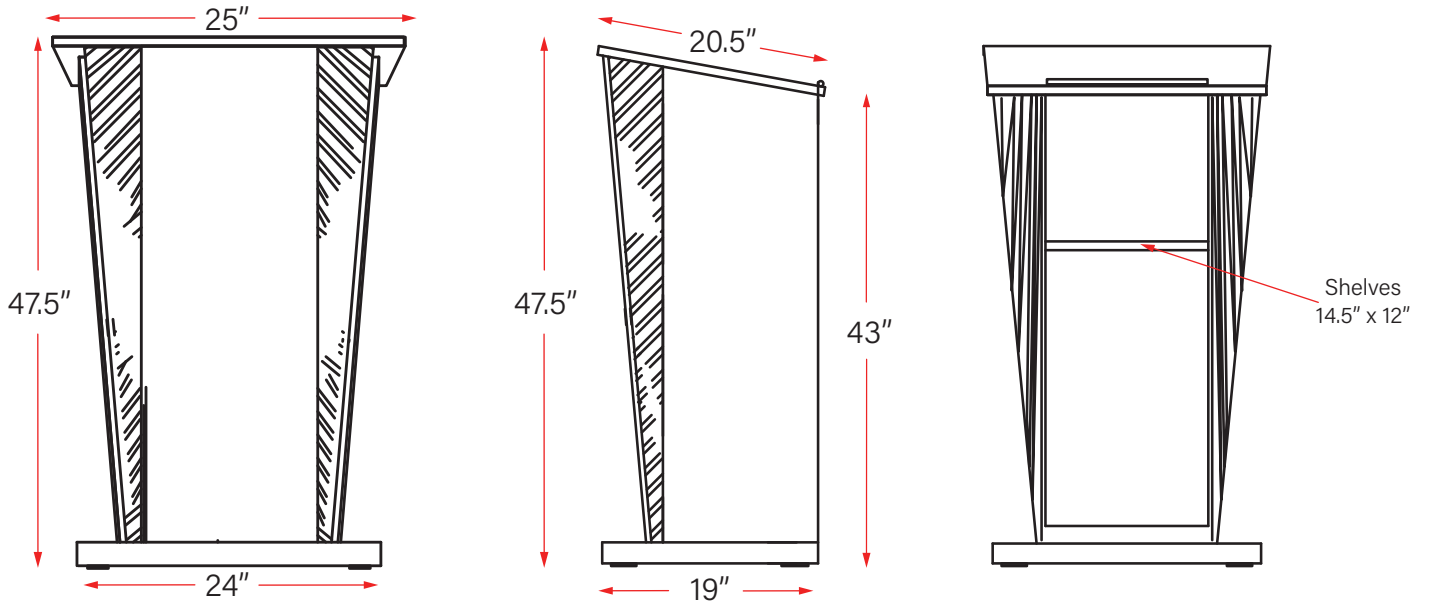

ASSEMBLED SHIPPING PACKAGE

Weight: ~335lbs

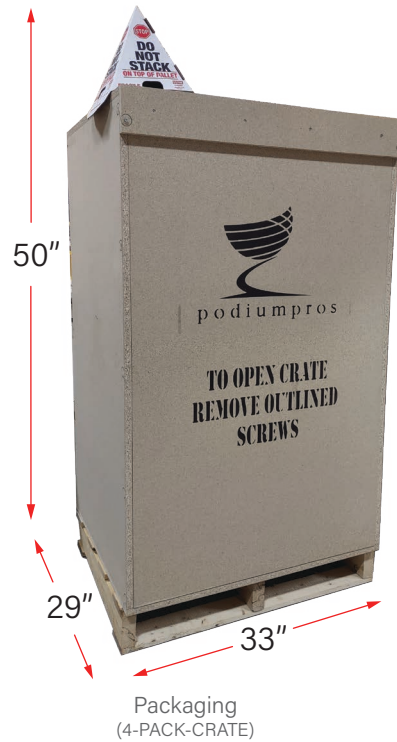



p o d i u m p r o s

modern lecterns with integrated innovations

