

# COLUMN ACRYLIC LINE

Modern lecterns designed with style and elegance.



# COLUMN

## DESCRIPTION:

Constructed of 1/2" polished acrylic, creating a seamless, transparent look.

CLEAR  
(SPEAKING SURFACE)



1AC-COL



front detail



side detail



back detail

# COLUMN

## DESCRIPTION:

Constructed of 1/2" polished acrylic, creating a seamless, transparent look. Equipped with two XLR board-mount connectors and one detachable 6" LED BNC-connected reading light.

# w/ AV Connections

CLEAR  
(SPEAKING SURFACE)

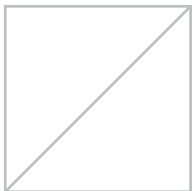

1AC-COL-WC



front detail



side detail



back detail



353 Saunders Rd, Unit 10-11, Barrie ON L4N 9A3  
Tel: 705-739-6745 Fax: 705-739-1228  
[www.podiumpros.com](http://www.podiumpros.com)



# COLUMN FS

## w/ AV Connections

### DESCRIPTION:

Constructed of 3/4" polished acrylic, creating a seamless, transparent look. Equipped with two XLR board-mount connectors and one detachable 6" LED BNC-connected reading light.

CLEAR  
(SPEAKING SURFACE)



1AC-COLFS-WC



front detail



side detail



back detail

# COLUMN FLARE

## w/ AV Connections

### DESCRIPTION:

Constructed of 3/4" polished acrylic, creating a seamless, transparent look. Equipped with two XLR board-mount connectors and one detachable 6" LED BNC-connected reading light.

CLEAR  
(SPEAKING SURFACE)



1AC-COLFLR-WC



front detail



side detail



back detail



Branding options for ourrylic Column podiums.

### VINYL APPLIED TO FRONT PANEL



Vinyl Signage  
(4-VS)

#### COLUMN



#### COLUMN FS

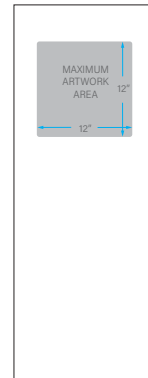

#### COLUMN FLARE

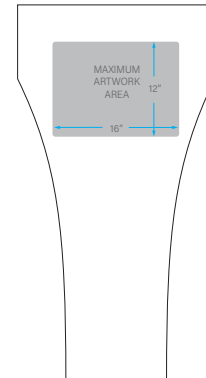

### FULL PANEL PRINT



Full Panel Vinyl Signage  
(4-VS-FULL)

#### COLUMN

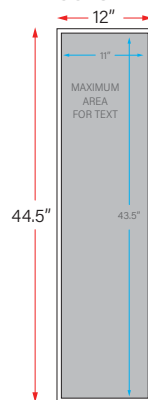

### MAGNETIC SIGN PANEL



Magnetic Sign Panel  
(Brushed Aluminum: 3-SIGN-MAG-AL)

#### COLUMN

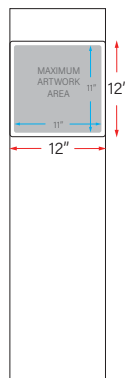

#### COLUMN FS

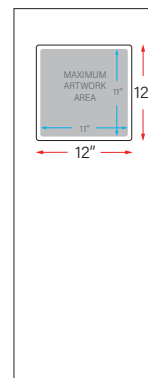

#### COLUMN FLARE

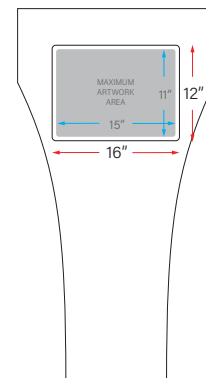

Branding options for our Acrylic Column podiums.

### ALUMOUNT SIGN BACKER



\*Brushed Aluminum shown

Alumount Sign Panel  
(3-SIGN-RETAIN3D)

#### COLUMN



#### COLUMN FS

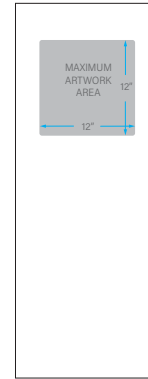

#### COLUMN FLARE

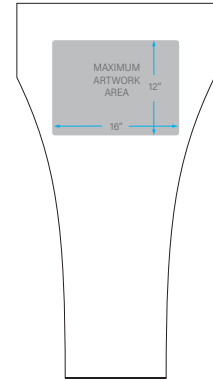

### ENGRAVED ACRYLIC SIGN PANEL

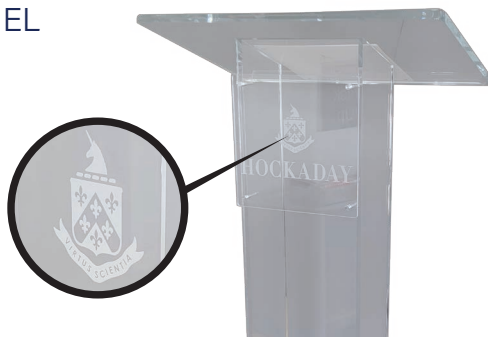

Engraved Acrylic Signage  
(3-SIGN-RETAINAG)  
(3-SIGN-LASER-AC)

#### COLUMN



#### COLUMN FS

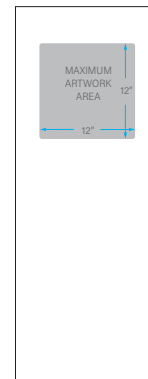

#### COLUMN FLARE

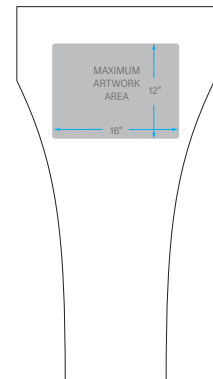

### 3D ACRYLIC LOGO

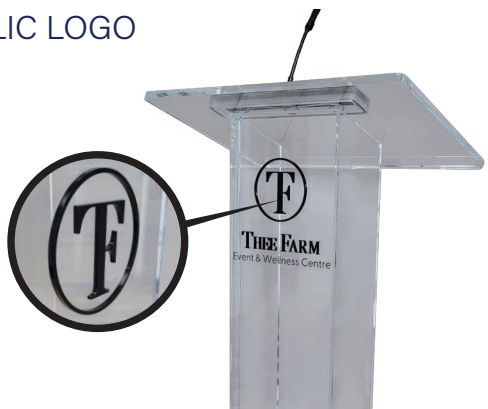

3D Acrylic Signage  
(3-SIGN-RETAIN3D)

#### COLUMN



#### COLUMN FS

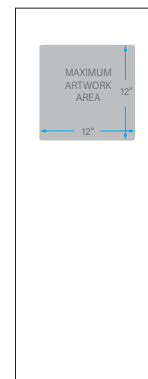

#### COLUMN FLARE

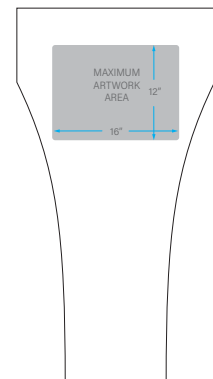

# DIMENSIONS

## DESCRIPTION:

- Dimensions and weight of assembled Acrylic Column podium.
- Dimensions and weight of assembled Acrylic Column podium, including packaging.

### ASSEMBLED ACRYLIC COLUMN PODIUM

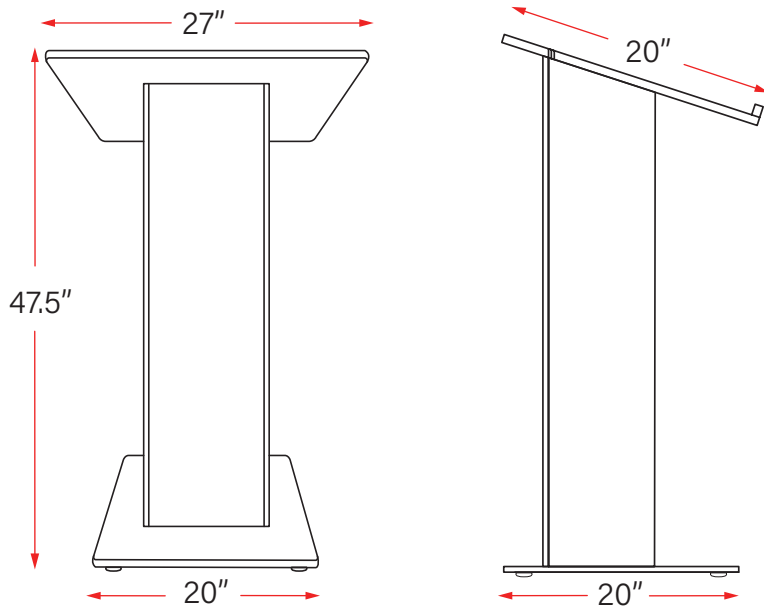

Weight: ~55lbs

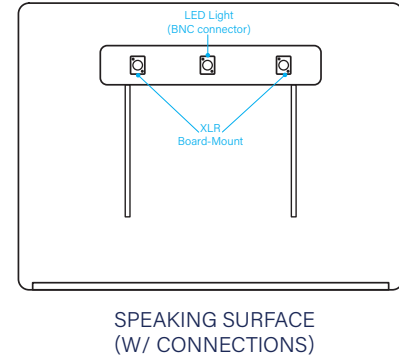

### ASSEMBLED SHIPPING PACKAGE



Weight: ~85lbs



# DIMENSIONS

## DESCRIPTION:

- Dimensions and weight of assembled Acrylic Column FS podium.
- Dimensions and weight of assembled Acrylic Column FS, including packaging.

### ASSEMBLED ACRYLIC COLUMN FS

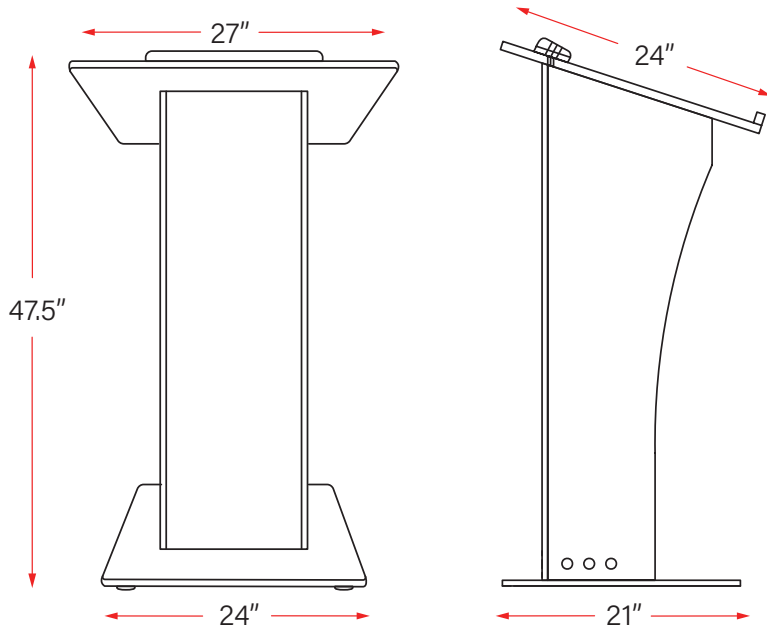

Weight: ~55lbs

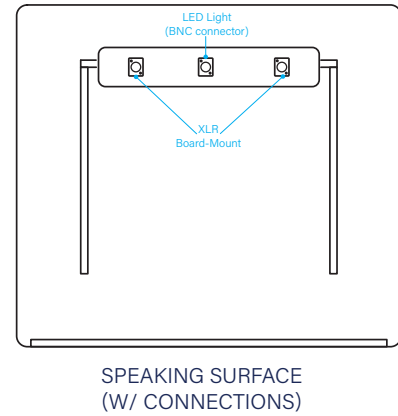

SPEAKING SURFACE  
(W/ CONNECTIONS)

### ASSEMBLED SHIPPING PACKAGE



Weight: ~85lbs



# DIMENSIONS

## DESCRIPTION:

- Dimensions and weight of assembled Acrylic Column Flare podium.
- Dimensions and weight of assembled Acrylic Column Flare, including packaging and crate.

### ASSEMBLED ACRYLIC COLUMN FLARE

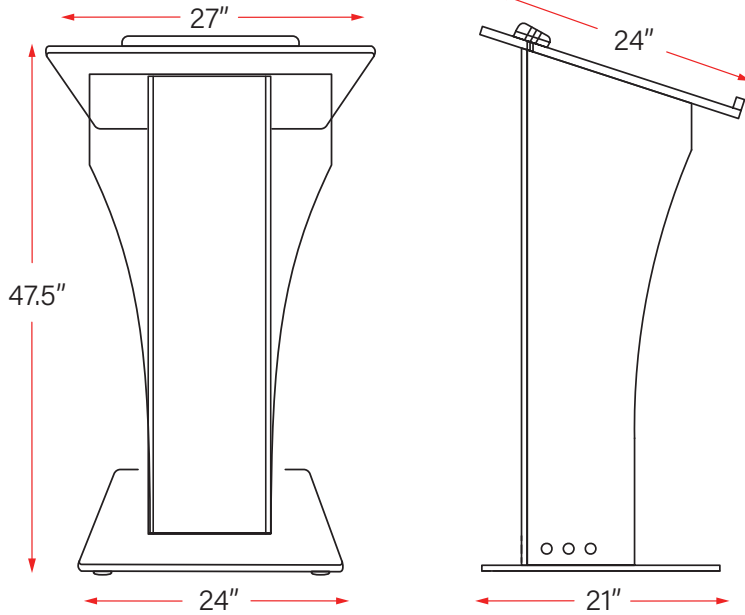

Weight: ~55lbs

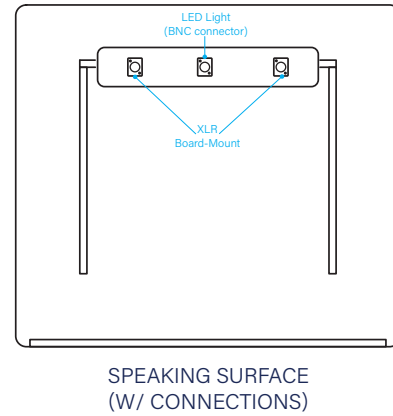

### ASSEMBLED SHIPPING PACKAGE



Weight: ~85lbs





p o d i u m p r o s

---

modern lecterns with integrated innovations

---

